



MODEL NUMBER SCHEME

e.g.: CG-120-277/480-3GY (as shown in above photo)



kA Rating (Must Choose One)

040	40kA per mode
060	60kA per mode
080	80kA per mode
100	100kA per mode
120	120kA per mode
150	150kA per mode
200	200kA per mode

Voltage (Must Choose One)

220-1G	220V, 1-Phase, 2-Wire + Ground
230-1G	230V, 1-Phase, 2-Wire + Ground
240-1G	240V, 1-Phase, 2-Wire + Ground
120/240-2G	120/240V, 2-Phase, 3-Wire + Ground
120/208-3GY	120/208V, 3-Phase Wye, 4-Wire + Ground
220/380-3GY	220/380V, 3-Phase Wye, 4-Wire + Ground
230/400-3GY	230/400V, 3-Phase Wye, 4-Wire + Ground
277/480-3GY	277/480V, 3-Phase Wye, 4-Wire + Ground
347/600-3GY	347/600V, 3-Phase Wye, 4-Wire + Ground
120/240-3GHD	120/240V, 3-Phase High-Leg Delta, 4-Wire + Ground (B-Phase must be 208V)
240-3DG	240V, 3-Phase Delta, 3-Wire + Ground
380-3DG	380V, 3-Phase Delta, 3-Wire + Ground
480-3DG	480V, 3-Phase Delta, 3-Wire + Ground
600-3DG	600V, 3-Phase Delta, 3-Wire + Ground

Available Option

S	Stainless Steel Enclosure
	Leave blank for Standard Enclosure

Stand-Alone Option (To Be Ordered As Separate Items)

DTS	DTS-2 Diagnostic Test Set
-----	---------------------------

SYSTEM FEATURES

- Listed to UL 1449 4th edition for Type 1 and Type 2 SPD applications.
- Innovative Z-Path System™ ensures equal current sharing, increased reliability and maximum performance
- Individually fused MOVs provide superior protection and continuous operation
- 200kAIC short circuit current rating allows direct bus connection without the need of an upstream over-current protection device
- Includes UL 1283 standard EMI/RFI filter
- All modes of protection (L-N, L-G, N-G & L-L)
- Standard monitoring includes Form "C" contacts and audible alarm with silence button
- DTS-2 compatible for proactive testing
- Ultra compact steel NEMA 4 enclosure makes installation flexible
- 10-Year standard product warranty

PRODUCT SPECIFICATIONS

General Specifications

Maximum Surge Current Rating	120kA per mode, 240kA per phase
Nominal Discharge Surge Current	I-n = 20kA
Safety Listings	UL Listed 1449 4th Edition for Type 1 and Type 2 SPD applications, cUL, and UL 1283 / Meets Requirements for UL 96A / Compliant to IEEE C62.41.1-2002, C62.41.2-2002 and C62.45-2002 / NFPA 70 [NEC], Article 285 / RoHS Compliant / CE, IEC 61643-11-2011 / FCC Part B Class B / EMC Directive 2004/108/EC / Low Voltage Directive 2006/95/EC
Repetitive Surge Current Rating	5,000 impulses per mode based on actual test data (using ANSI/IEEE C62.41.1-2002 C3 combo wave)
Product Design	Hybrid parallel design Individually fused MOVs UL 1283 EMI/RFI Filter
Application	ANSI/IEEE C62.41.1 Locations C, B & A Ideal for Low Exposure Service Entrance, Distribution Panels, Motor Control Centers and Branch Panels
Standard Monitoring	Status indicator lights (one per phase) Service indicator light Form C contacts (NO/NC) Audible alarm with silence button
Fault Current (SCCR)	200kAIC – no upstream over-current protection device (breaker or fuse) required
Connection Method	Parallel
Protection Modes	All Modes (L-N, L-G, N-G, L-L)
Response Time	< 0.5 Nanoseconds
Operating Frequency	47 – 63 Hz
Warranty	10 Year

EMI / RFI Filter Attenuation – Mil Standard 220B

Up to 33 dB from 10 KHz to 100 MHz

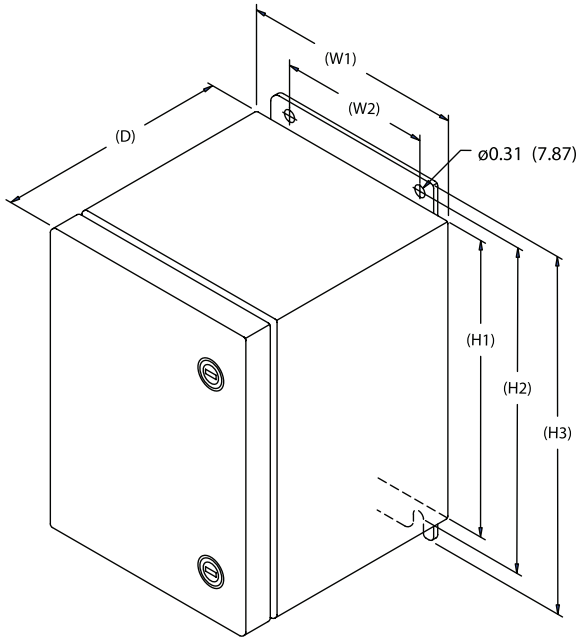

DIMENSIONAL SPECIFICATIONS

CG120	Inches	(mm)
H1	14.00	(355.6)
H2	14.75	(374.7)
H3	15.50	(393.7)
W1	12.75	(323.9)
W2	10.75	(273.1)
D	6.30	(160.0)

MECHANICAL SPECIFICATIONS

Enclosure Type	Powder coated, impact-resistant steel, weather-proof NEMA 4
Installation Location	Indoor or outdoor
Dimensions	14"H x 12.75"W x 6.3"D
Connection Method	Hard-wired via internal lugs #10 AWG – #3 AWG
Mounting Method	Dual mounting flanges
Operating Environment	-40° F to +158° F (-40° C to +70° C) 5% – 95% non-condensing humidity
Weight	40 lbs.

CURRENTGUARD 120 PERFORMANCE DATA

Model Number	CG120-220-1G CG120-230-1G CG120-240-1G			CG120-120/240-2G CG120-120/208-3GY				CG120-220/380-3GY CG120-230/400-3GY CG120-277/480-3GY				CG120-347/600-3GY				CG120-120/240-3GHD						CG120-240-3GD		CG120-380-3GD		CG120-480-3GD		CG120-600-3GD	
System Voltage	220V 230V 240V			120/240V 120/208V				220/380V 230/400V 277/480V				347/600V				120/240V						240V		380V 480V		600V			
Protection Mode	L-N	L-G	N-G	L-N	L-G	L-L	N-G	L-N	L-G	L-L	N-G	L-N	L-G	L-L	N-G	L-N	H-N	L-G	H-G	L-L	H-L	N-G	L-G	L-L	L-G	L-L	L-G	L-L	
MCOV	320	320	320	150	150	300	150	320	320	640	320	420	420	840	420	150	320	150	320	300	470	150	320	320	550	550	750	750	
B3 Ring Wave 6kV, 500A	660	750	720	420	480	610	340	660	750	960	720	715	829	1130	670	420	759	470	640	605	800	320	750	630	1050	860	1245	1060	
B3/C1 Combo Wave 6kV, 3kA	910	1068	974	642	690	1010	620	910	1068	1700	974	1250	1340	2300	1230	642	910	690	1068	1010	1400	620	940	1020	1450	1670	1960	2260	
C3 Combo Wave 20kV, 10kA	1490	1830	1690	1040	1300	1420	1240	1490	1830	2290	1690	1910	1960	2910	1880	1040	1490	1300	1830	1420	2050	1240	1650	1680	2160	2470	2760	2950	
UL1449 3 rd Edition 6kV, 3000A VPR	1200	1200	1000	700	700	1200	700	1200	1200	1800	1000	1500	1500	2500	1200	700	1200	700	1200	1200	1500	700	1200	1200	1800	1800	2500	2500	

All CurrentGuard™ systems measured limited voltages are peak values (±10%) measured from the zero reference point and are in compliance with test and evaluation procedures outlined in NEMA LS1-1992 (R2000), paragraphs 2.210 and 3.10.

Specifications subject to change without notice, refer to www.currenttechnology.com for latest revision.





Energía Verde RMS

Ahorra y contribuye con tu ambiente [®]

General Miguel Barragán #814
Aguascalientes, Ags.
01 (449) 145 2028
energiaverderms.com.mx